

Latest Innovations

Innovative solutions developed across all areas of technology.

Product Catalogue

Two Channel Sifter

SE-TCC 64-20
SE-TCC 64-24
SE-TCC 74-20
SE-TCC 74-24

Technological Advantages

Across All Markets and Sectors

SE-TCC TWO CHANNEL SIFTER- APPLICATION OVERVIEW

The SE-TCC Two Channel Sifter is engineered for precise and reliable control sifting of flour, semolina, corn flour, and other granular products in modern milling and food processing plants. Designed as a high-efficiency safety and control unit, it is widely used in wheat flour mills, semolina factories, corn processing facilities, whole wheat flour production lines, and various food manufacturing operations where consistent particle separation and product purity are essential. Operating through a dual-channel sifting system, the SE-TCC Two Channel Sifter enables simultaneous and balanced screening processes, ensuring higher capacity and improved efficiency compared to single-channel systems. The two independent sifting channels provide enhanced separation accuracy while effectively removing oversized particles and foreign materials from the final product stream. Built for continuous industrial operation, the SE-TCC delivers stable performance, uniform product distribution, and minimal material loss. Its optimized internal sieve configuration and dynamically balanced drive mechanism ensure smooth material flow, reduced vibration levels, and energy-efficient performance. The hygienic and compact design allows seamless integration into existing production lines while supporting easy maintenance, operational reliability, and extended service life. The SE-TCC Two Channel Sifter enhances process safety, improves final product quality, and increases overall production efficiency, making it a reliable solution for controlled and high-performance milling operations.

FEATURES & ADVANTAGES

- ▶ Accurate control sifting through a single dedicated channel
- ▶ Ensures reliable removal of oversize particles and impurities
- ▶ Stable and uniform screening performance with minimal product loss
- ▶ Compact design for easy integration into existing processing lines
- ▶ Balanced drive system for smooth and low-vibration operation
- ▶ Hygienic construction suitable for food-grade applications
- ▶ Easy access for sieve inspection, cleaning, and maintenance
- ▶ Low energy consumption and reduced operating costs

APPLICATION FIELDS

- ▶ Wheat flour mills
- ▶ Whole wheat flour milling plants
- ▶ Semolina (durum wheat) production lines
- ▶ Pasta flour production facilities
- ▶ Corn flour milling plants
- ▶ Rusk (galeta) flour mills
- ▶ Starch production plants
- ▶ Milling, sifting, and quality control sections

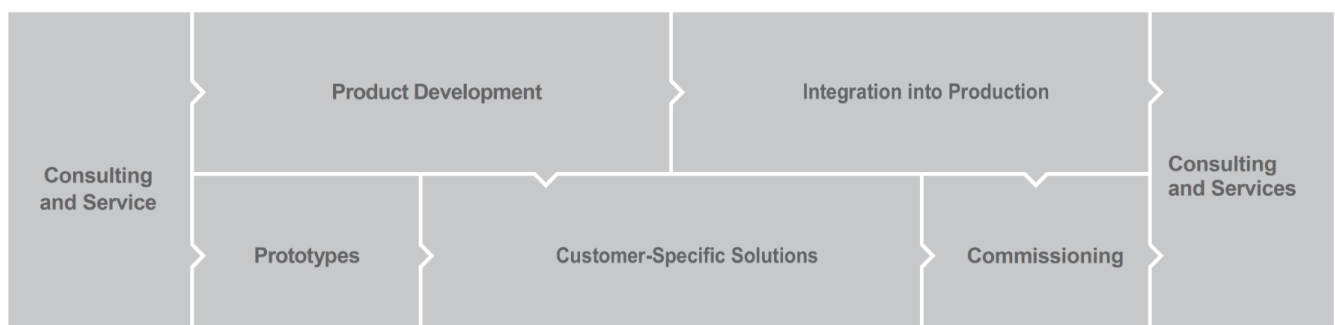

Technical Table

Two Channel Sifter

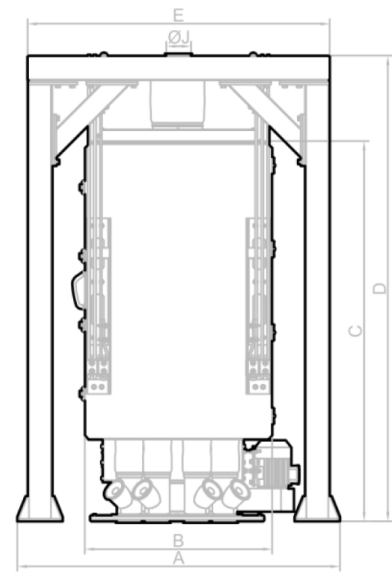
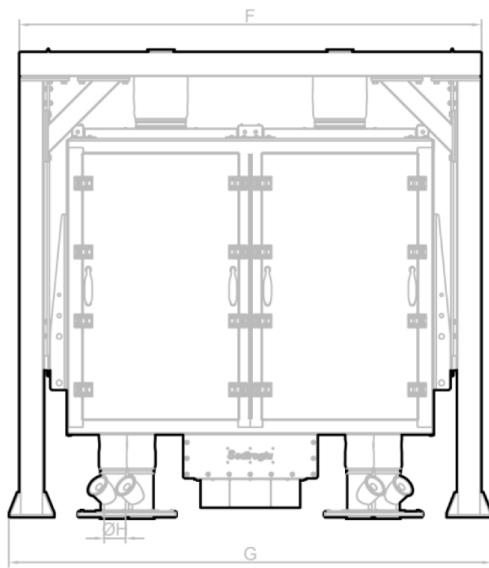
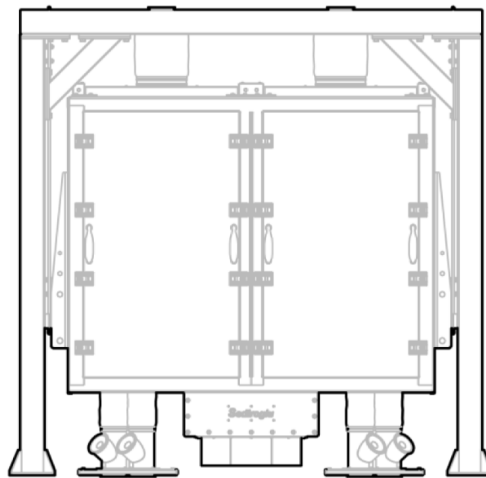

MODEL MODELE	DIMENSIONS mm.									TECHNICAL FEATURES CARACTERISTIQUES TECHNIQUES									
	A	B	C	D	E	F	G	ØH	ØJ	Motor Moteur Kw	Eccentr. Eccentr. (mm)	Net area/ fr. Surface bul. (m ²)	Opening of mesh Ouverture de maille (micron)	Capacity Capacité t/h	Weights - Poids Kg		Volume sous Gross volume emballage m ³		
															Net	Gross-Brut			
SE-TCC 64/20	1462	806	1951	2385	1362	2037	2137	120	200	1,5	55	6,96	300	5-7	1310	1620	3.8		
SE-TCC 64/24																			
SE-TCC 74/20	1562	906			1462	2237	2337	150	2,2					9,53		14-16	1500	1810	6.6
SE-TCC 74/24																			
													11.43			16-19	1600	1922	7.3

Sample Sieve Frames

For more information, please refer to the spare parts section.

TYPE: SE-AN-RIGTH

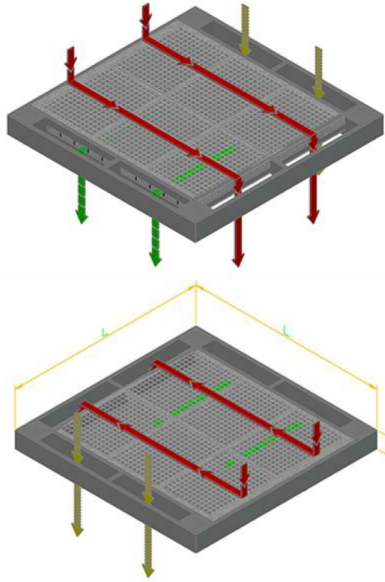

TYPE

DIMENSION (mm)

N

L

H

SE-AN6457-RIGTH

640

57

SE-AN6462-RIGTH

640

62

SE-AN6472-RIGTH

640

72

SE-AN6482-RIGTH

640

82

SE-AN6492-RIGTH

640

92

SE-AN64102-RIGTH

640

102

SE-AN7457-RIGTH

740

57

SE-AN7462-RIGTH

740

62

SE-AN7472-RIGTH

740

72

SE-AN7482-RIGTH

740

82

SE-AN7492-RIGTH

740

92

SE-AN74102-RIGTH

740

102

TYPE: SE-BN-RIGTH

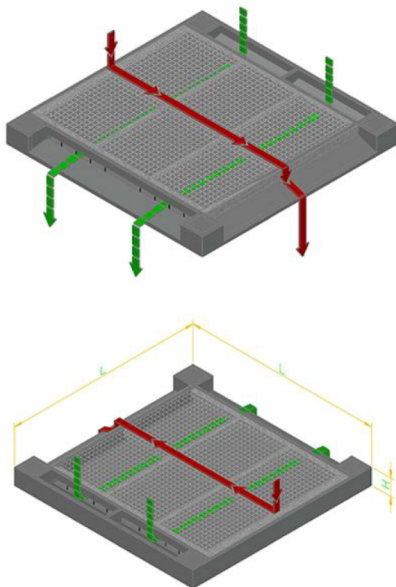

TYPE

DIMENSION (mm)

N

L

H

SE-BN6482-RIGTH

640

82

SE-BN6492-RIGTH

640

92

SE-BN64102-RIGTH

640

102

SE-BN7482-RIGTH

740

82

SE-BN7492-RIGTH

740

92

SE-BN74102-RIGTH

740

102

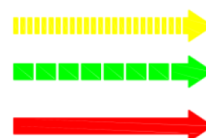

FEED THE BOTTOM SECTION

THROUGHS

OVERTAILS

Sample Sieve Frames

For more information, please refer to the spare parts section.

TYPE: SE-CN-LEFT

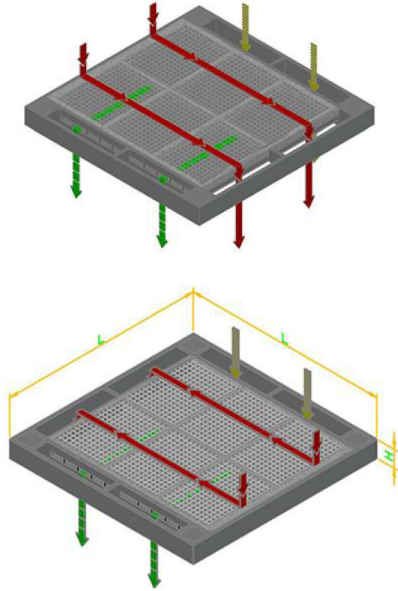

TYPE	DIMENSION (mm)	
	L	H
N		
SE-CN6457-LEFT	640	57
SE-CN6462- LEFT	640	62
SE-CN6472- LEFT	640	72
SE-CN6482- LEFT	640	82
SE-CN6492- LEFT	640	92
SE-CN64102- LEFT	640	102
SE-CN7457- LEFT	740	57
SE-CN7462- LEFT	740	62
SE-CN7472- LEFT	740	72
SE-CN7482- LEFT	740	82
SE-CN7492- LEFT	740	92
SE-CN74102- LEFT	740	102

TYPE: SE-DN-DOUBLE

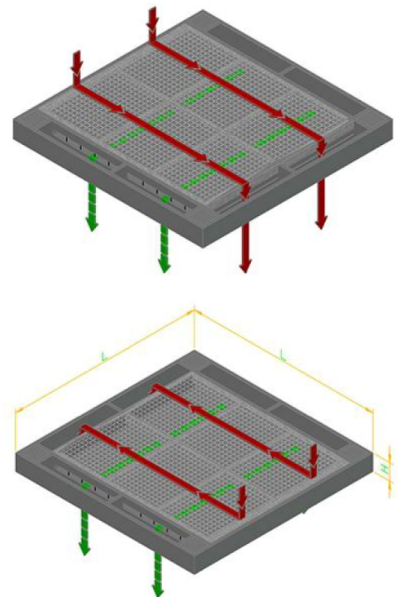

TYPE	DIMENSION (mm)	
	L	H
N		
SE-DN6457-DOUBLE	640	57
SE-DN6462- DOUBLE	640	62
SE-DN6472- DOUBLE	640	72
SE-DN6482- DOUBLE	640	82
SE-DN6492- DOUBLE	640	92
SE-DN64102- DOUBLE	640	102
SE-DN7457- DOUBLE	740	57
SE-DN7462- DOUBLE	740	62
SE-DN7472- DOUBLE	740	72
SE-DN7482- DOUBLE	740	82
SE-DN7492- DOUBLE	740	92
SE-DN74102- DOUBLE	740	102

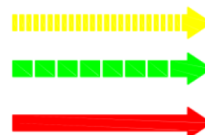

FEED THE BOTTOM SECTION

THROUGHS

OVERTAILS

Sample Sieve Frames

For more information, please refer to the spare parts section.

TYPE: SE-EN-RIGTH

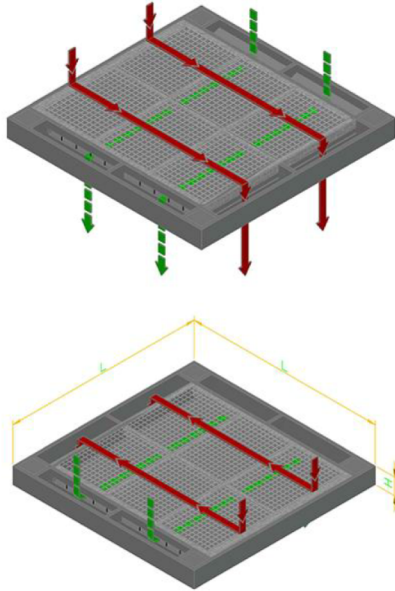

TYPE	DIMENSION (mm)	
	L	H
N		
SE-EN6462- RIGTH	640	62
SE-EN6472- RIGTH	640	72
SE-EN6482- RIGTH	640	82
SE-EN6492- RIGTH	640	92
SE-EN64102- RIGTH	640	102
SE-EN7462- RIGTH	740	62
SE-EN7472- RIGTH	740	72
SE-EN7482- RIGTH	740	82
SE-EN7492- RIGTH	740	92
SE-EN74102- RIGTH	740	102

TYPE: SE-FN-TKD

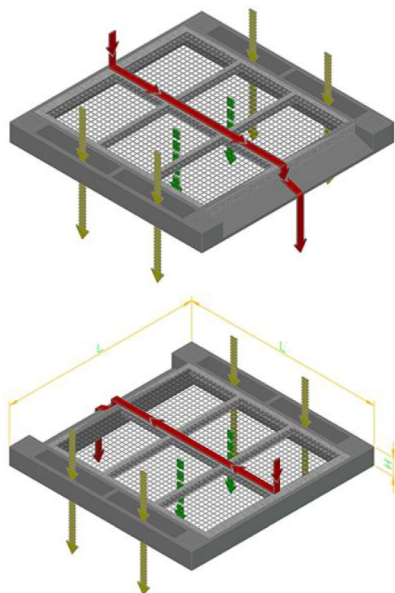

TYPE	DIMENSION (mm)	
	L	H
N		
SE-FN6457-TKD	640	57
SE-FN6462- TKD	640	62
SE-FN6472- TKD	640	72
SE-FN6482- TKD	640	82
SE-FN6492- TKD	640	92
SE-FN64102- TKD	640	102
SE-FN7457- TKD	740	57
SE-FN7462- TKD	740	62
SE-FN7472- TKD	740	72
SE-FN7482- TKD	740	82
SE-FN7492- TKD	740	92
SE-FN74102- TKD	740	102

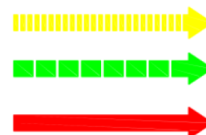

FEED THE BOTTOM SECTION

THROUGHS

OVERTAILS

Sample Sieve Frames

For more information, please refer to the spare parts section.

TYPE: SE-GN-LEFT

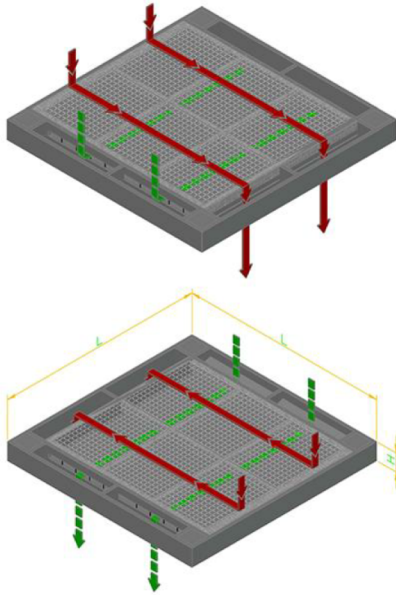

TYPE	DIMENSION (mm)	
	L	H
N		
SE-GN6462- LEFT	640	62
SE-GN6472- LEFT	640	72
SE-GN6482- LEFT	640	82
SE-GN6492- LEFT	640	92
SE-GN64102- LEFT	640	102
SE-GN7462- LEFT	740	62
SE-GN7472- LEFT	740	72
SE-GN7482- LEFT	740	82
SE-GN7492- LEFT	740	92
SE-GN74102- LEFT	740	102

TYPE: SE-HN-RIGTH

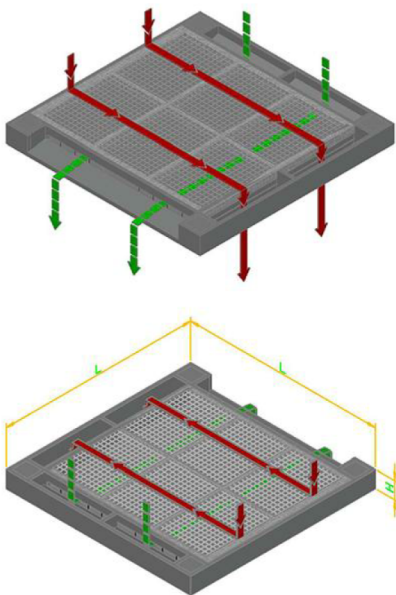

TYPE	DIMENSION (mm)	
	L	H
N		
SE-HN6462- RIGTH	640	62
SE-HN6472- RIGTH	640	72
SE-HN6482- RIGTH	640	82
SE-HN6492- RIGTH	640	92
SE-HN64102- RIGTH	640	102
SE-HN7462- RIGTH	740	62
SE-HN7472- RIGTH	740	72
SE-HN7482- RIGTH	740	82
SE-HN7492- RIGTH	740	92
SE-HN74102- RIGTH	740	102



Sample Sieve Frames

For more information, please refer to the spare parts section.

TYPE: SE-IN-LEFT

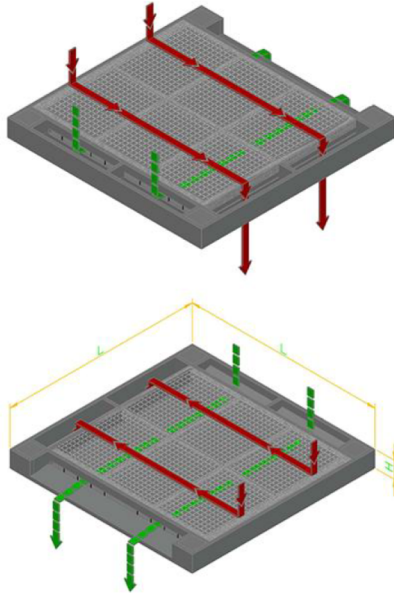

TYPE	DIMENSION (mm)	
	L	H
N		
SE-IN6462- LEFT	640	62
SE-IN6472- LEFT	640	72
SE-IN6482- LEFT	640	82
SE-IN6492- LEFT	640	92
SE-IN64102- LEFT	640	102
SE-IN7462- LEFT	740	62
SE-IN7472- LEFT	740	72
SE-IN7482- LEFT	740	82
SE-IN7492- LEFT	740	92
SE-IN74102- LEFT	740	102

TYPE: SE-JN-RIGTH

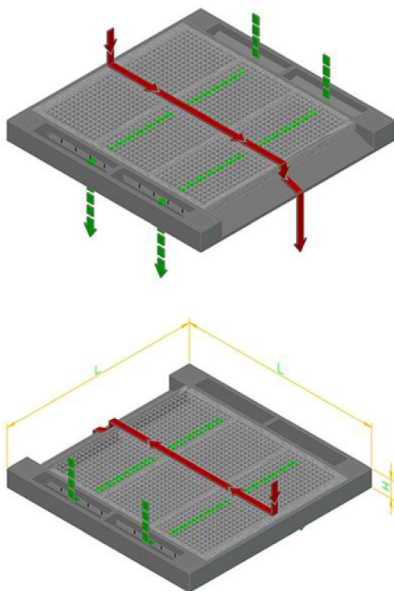

TYPE	DIMENSION (mm)	
	L	H
N		
SE-JN6472- RIGTH	640	72
SE-JN6482- RIGTH	640	82
SE-JN6492- RIGTH	640	92
SE-JN64102- RIGTH	640	102
SE-JN7472- RIGTH	740	72
SE-JN7482- RIGTH	740	82
SE-JN7492- RIGTH	740	92
SE-JN74102- RIGTH	740	102



Sample Sieve Frames

For more information, please refer to the spare parts section.

TYPE: SE-KN-LEFT

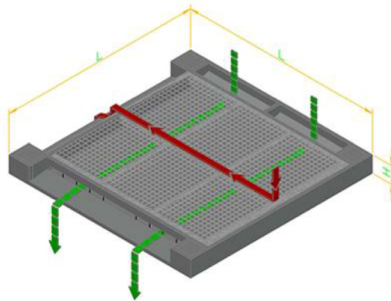
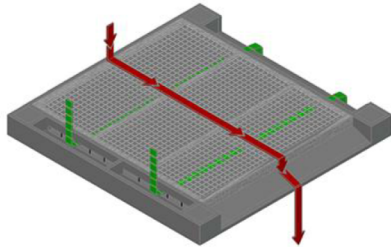

TYPE

DIMENSION (mm)

N

L

H

SE-KN6482- LEFT

640

82

SE-KN6492- LEFT

640

92

SE-KN64102- LEFT

640

102

SE-KN7482- LEFT

740

82

SE-KN7492- LEFT

740

92

SE-KN74102- LEFT

740

102

TYPE: SE-LN-LEFT

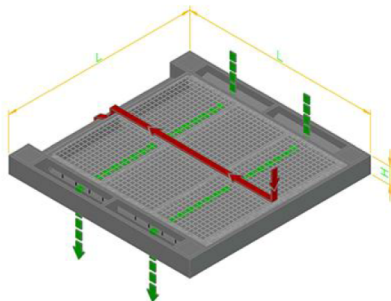
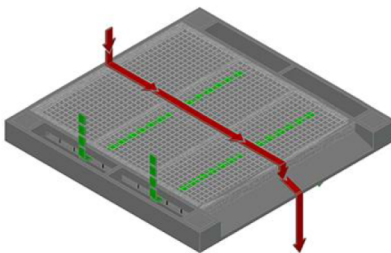

TYPE

DIMENSION (mm)

N

L

H

SE-LN6472- LEFT

640

72

SE-LN6482- LEFT

640

82

SE-LN6492- LEFT

640

92

SE-LN64102- LEFT

640

102

SE-LN7472- LEFT

740

72

SE-LN7482- LEFT

740

82

SE-LN7492- LEFT

740

92

SE-LN74102- LEFT

740

102

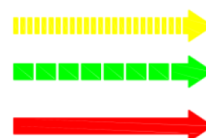

FEED THE BOTTOM SECTION

THROUGHS

OVERTAILS

SEDIROGLU GROUP DELIVERS COMPLETE SOLUTIONS ACROSS VARIOUS INDUSTRIES, COMBINING DEEP TECHNICAL EXPERTISE WITH A DIVERSE AND EXTENSIVE PRODUCT RANGE TO MEET A WIDE SPECTRUM OF CUSTOMER NEEDS.

FACING A DEVELOPMENT CHALLENGE? WE PROVIDE THE SOLUTION.
AT SEDIROGLU GROUP, OUR EXPERIENCED R&D TEAM IS COMMITTED TO CONTINUOUS IMPROVEMENT.
MANY INDUSTRY INNOVATIONS HAVE ORIGINATED FROM OUR COMPANY.
WE ARE DRIVEN BY A FORWARD-THINKING MINDSET AND A PIONEERING SPIRIT IN EVERY STEP WE TAKE.

CONTACT – WORLDWIDE

With 12 branches around the world and marketing teams in over 70 countries, we provide you with outstanding service worthy of a technology leader.

We look forward to hearing from you!

<https://sedirolugroup.com/contact>



AT YOUR SERVICE 24/7 – OUR VIRTUAL BOOTH

With impressive features like animated shots, clickable hotspots, and rotatable 3D models, we are confident our online presentations will truly impress you.

<https://sedirolugroup.com/products>



DISCOVER MORE ABOUT THIS PRODUCT

Scan the QR code to access detailed technical specifications, application insights, high-quality visuals, and interactive digital content related to this product.

<https://sedirolugroup.com/products/two-channel-sifter>



HEAD OFFICE:
SEDIROGLU GROUP
Turkey, Çorum
T +90 541 620 03 22
E Mail : info@sedirolu.com
E Mail : info@sedirolugroup.com

www.sedirolugroup.com

Sedirolu
GROUP machine